

ARTERIO RS

COLEMAN CHANDELIER

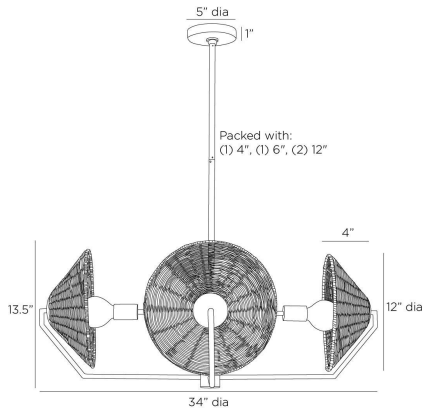

DMC23
Natural, Rattan

Contemporary silhouettes meet traditional materials. A quartet of umbrella shades in natural rattan are suspended with streamlined fixture plated in English bronze steel. Suspended from a sleek matching canopy, each reflective shape allows a play of light and shadow. Ideal for both a modern and coastal environment. Finish will vary.

APPEARANCE

Materials	Rattan, Steel
Finishes	Natural, English Bronze
Finish Will Vary	Yes
Top Coat/Sealant	No

DIMENSIONS

Overall	Dia: 34.0 in x H: 18.5 in
Shade	Dia: 12.0 in x H: 4 in
Canopy	Dia: 5.0 in x H: 1 in
Chandelier	Dia: 34.0 in x H: 13.5 in
Overall Hanging Height as Sold (in)	18.5 in - 48.5 in

WIRING

Wire Rating	Damp
Cord	10 FT, Clear/Silver, SVT
Socket	4, Type A - E26
Suggested Bulb Type	G25
Maximum Wattage	60.0
Voltage	110-120 V

CERTIFICATIONS & COMPLIANCY

Certifications	Middle East, European Union, United Kingdom, Australia, Mexico, United States, Canada
Compliance	RoHS, UL/ETL, CB

SHIPPING

Product Weight	9.0 lbs
Gross Weight 1	14.3 lbs
Shipping Box 1	W: 15.0 in x D: 28.0 in x H: 28.0 in

CONTRACT

Contract Suitability	Contract Suitable As Is
----------------------	-------------------------

SLOPE CEILING COMPATIBILITY

Sloped Ceiling Compatible	No, is not compatible
---------------------------	-----------------------

COMPONENTS

Pipe or Chain Included	(1) 4", (1) 6", (2) 12" Pipes
------------------------	-------------------------------

ADDITIONAL PARTS AVAILABLE

PIPE-240	(1) 4", (1) 6", (1) 12"
----------	-------------------------

REPLACEMENT PARTS

CANOPY-510
