

ARTERIOS

SUMTER CANDLE CHANDELIER

Beth Webb

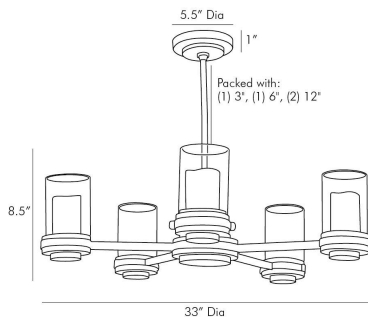

DW82003
Clear, Glass

The five-armed Sumter Candle chandelier is elemental and graphic in shape mingling natural wood clear glass cylinders iron arms and wood-inset details. The pared down silhouette is aesthetically versatile and could reside in a country farmhouse or an urban minimal apartment. Ivory resin candle sleeves lend a certain romanticism to the piece. Certified for damp locations and intended for interior use.

APPEARANCE

Materials	Glass, Glass, Wood, Iron
Finishes	Clear, Clear, Natural, Bronze
Finish Will Vary	Yes
Top Coat/Sealant	No

DIMENSIONS

Overall	Dia: 33.0 in x H: 10.5 in
Canopy	Dia: 5.5 in x H: 1 in
Chandelier	Dia: 33.0 in x H: 8.5 in
Overall Hanging Height as Sold (in)	10.5 in - 37.5 in

WIRING

Wire Rating	Damp
Cord	10 FT, Black, SVT
Socket	5, Type B - E12
Suggested Bulb Type	B8
Maximum Wattage	25.0
Voltage	110-120 V

CERTIFICATIONS & COMPLIANCY

Certifications	Middle East, European Union, United Kingdom, Mexico, United States, Canada
Compliance	RoHS, UL/ETL, CB

SHIPPING

Product Weight	20.5 lbs
Gross Weight 1	37.7 lbs
Gross Weight 2	7.0 lbs
Shipping Box 1	W: 13.0 in x D: 35.6 in x H: 35.5 in
Shipping Box 2	W: 7.9 in x D: 22.9 in x H: 21.1 in

CONTRACT

Contract Suitability	Contract Suitable As Is
----------------------	-------------------------

SLOPE CEILING COMPATIBILITY

Sloped Ceiling Compatible	No, is not compatible
---------------------------	-----------------------

COMPONENTS

Pipe or Chain Included	(1) 3", (1) 6", (2) 12"
------------------------	-------------------------

ADDITIONAL PARTS AVAILABLE

PIPE-456	(1) 3", (1) 6", (1) 12"
----------	-------------------------

REPLACEMENT PARTS

CANOPY-465
DW82003GLS