

ARTERIOS

TERRACE PENDANT

Celerie Kemble

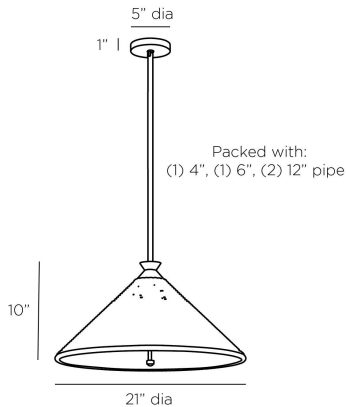

GCDS501
Natural, Rattan

A continuation of the Terrace family, this pendant is made up of natural, handwoven rattan that brings a caribbean sophistication feel to the piece. With accents crafted of gold steel finished iron, the contrast points accentuate the whimsical silhouette. Finish will vary.

APPEARANCE

Materials	Rattan, Iron
Finishes	Natural, Gold Steel
Finish Will Vary	Yes
Top Coat/Sealant	Yes

DIMENSIONS

Overall	Dia: 21.0 in x H: 13.5 in
Diffuser	Dia: 19.0 in
Canopy	Dia: 5.0 in x H: 1 in
Pendant	Dia: 21.0 in x H: 10 in
Overall Hanging Height as Sold (in)	13.5 in - 43.5 in

WIRING

Wire Rating	Indoor Only
Socket	2, Type A - E26
Suggested Bulb Type	A19
Maximum Wattage	60.0
Voltage	110-120 V

CERTIFICATIONS & COMPLIANCY

Certifications	Middle East, European Union, United Kingdom, Australia, Mexico, United States, Canada
Compliance	RoHS, UL/ETL, CB

SHIPPING

Product Weight	4.6 lbs
Gross Weight 1	14.0 lbs
Shipping Box 1	W: 21.0 in x D: 21.0 in x H: 14.0 in

ADDITIONAL INFO

Features	Sustainable
----------	-------------

CONTRACT

Contract Suitability	Contract Suitable As Is
----------------------	-------------------------

SLOPE CEILING COMPATIBILITY

Sloped Ceiling Compatible	No, is not compatible
---------------------------	-----------------------

COMPONENTS

Pipe or Chain Included	(1) 4", (1) 6", (2) 12" Pipes
------------------------	-------------------------------

ADDITIONAL PARTS AVAILABLE

PIPE-256	(1) 6", (1) 12"
----------	-----------------

REPLACEMENT PARTS

CANOPY-686
